

Gamme CPP Max



Poignée ergonomique et robinetterie chromée.



Attache aimanté. Sangle en Option



L'intérieur du CPP EAU possède un revêtement plascoat anti-corrosion.





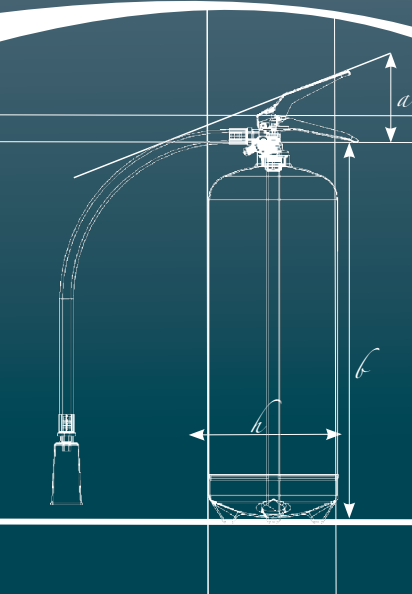



Lecture claire et simple de la pression de service



EN 3-7 + A1



EN 3-8



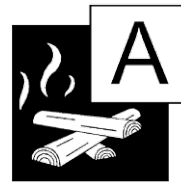

Type d'extincteur <i>Extinguisher Type</i>	CPP6	CPP9
N° de certification NF-EN 3-7 + A1 <i>NF-EN 3-7 + A1 approval</i>	EP6 045 569	EP6 045 633
	27A	27A
	183B	233B
		
Agent Extincteur <i>Extinguishing agent</i>	6kg ABC HJABC40	9Kg ABC HJABC 40
Temps de fonctionnement <i>Operating time</i>	23,7s	22,3s
Agent propulseur <i>Propellant agent</i>	15 bar azote	15 bar azote
Hauteur hors tout <i>Overall height</i>	545 mm	605 mm
Diamètre extérieur <i>Overall diameter</i>	160 mm	180 mm
Certifié avec support transport <i>Certified with its transportation support</i>		
Code article <i>Item code</i>	XD-CPP6	XD-CPP9



Extincteur à poudre ABC



Extincteur à eau + additif

Type d'extincteur <i>Extinguisher Type</i>	CPP6L	CPP9L
N° de certification NF-EN 3-7 + A1 <i>NF-EN 3-7 + A1 approval</i>	EA6 045 631	EA9 045 632
	13A	21A
	144B	183B
Agent Extincteur <i>Nominal charge</i>	6L eau + additif	9L eau + additif
Temps de fonctionnement <i>Operating time</i>	17,5s	28,3s
Agent propulseur <i>Propellant agent</i>	15 bar azote	15 bar azote
Additif en pré-mélange <i>Sparklet capacity</i>	6%	6%
Hauteur hors tout <i>Overall height</i>	565 mm	620 mm
Diamètre extérieur <i>Overall diameter</i>	160 mm	180 mm
Certifié avec support transport <i>/ Certified with its transportation support</i>		
Code article <i>Item code</i>	XD-CPP6L	XD-CPP9L

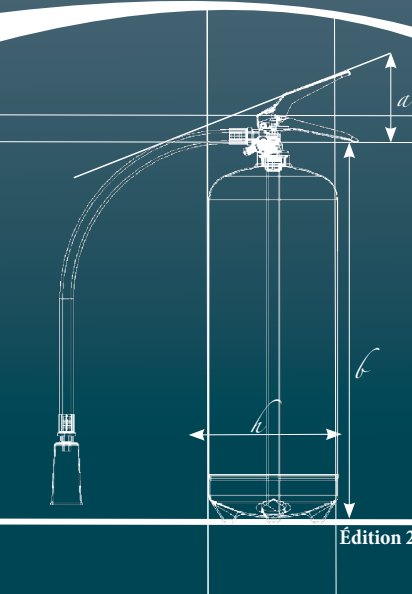

FRANCE PROTECTION FEU

Paris : 01 84 17 77 90

Orleans : 02 38 51 32 06

Blois : 09 72 54 73 09

Tours : 02 46 65 5019

contact@franceprotectionfeu.com